

Description	Pilot-actuated pressure valve with precisely adjustable pilot setpoint. Perfect for applications which require intrinsic safety, pneumatic sequencing or pressure relief. Valves are normally opened or closed. The switch complies with FDA regulations and is suitable for water and food products.		
Media	5 µm filtered compressed air		
Pressure valve	3-port/2-way air-assisted servo valve with exhaust to atmosphere, NO or NC, made of nylon		
	Supply pressure:	1.4...8 bar, untapped exhaust	
	Air consumption:	max. 0.3 l/min at 2 bar supply pressure or max. 0.7 l/min at 7 bar	
	Pneumatic connection:	quick connector for hose external diameter of 4 mm (5/32")	
	Flow rate:	70 l/min at 7 bar, nominal size DN 0.2, K _v = 0.05	
	Switching time:	64 ms at 6 bar supply pressure	
Accuracy	Pressure switch:	at supply pressure variation of 0.7 bar: < 7 mbar pressure deviation	
	Vacuum switch:	at supply pressure variation of 0.3 bar: < 3 mbar pressure deviation	
	Repeatability:	± 2% FS	
Temperature range	4 °C to 60 °C / 40 °F to 140 °F		
Material	Body:	polysulphone	
	Diaphragm:	polyurethane	
	Mounting position	any	
	Spring:	stainless steel	
	Media non-contact parts:	nylon, carbon fibre nylon, acetal	

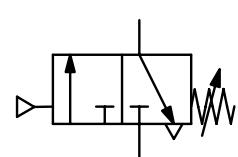

70 ... 350 mbar / 7 bar
-30 ... -170 / -850 mbar

Switches
12

Description	Supply pressure of switching valve	Hysteresis typical	Hysteresis max.	Over-pressure max. bar	Measurement range bar	Order number
-------------	------------------------------------	--------------------	-----------------	------------------------	-----------------------	--------------

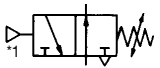
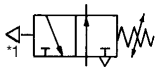
Switch with pneumatic output, NO	1/8" NPT male, supply pressure 1.4...8 bar		PP / VP700			
 pressure switch	1.4 ... 8 bar	15	30	2	0.07 ... 0.35	PP700- 5PT
		20	40	4	0.07 ... 1.0	PP700- 15PT
	NO	20	70	4	0.07 ... 2.1	PP700- 30PT
		35	140	8	0.20 ... 4.2	PP700- 60PT
		50	240	8	0.35 ... 7.0	PP700-100PT
 vacuum switch	1.4 ... 8 bar	15	35	-1	-0.03 ... -0.17	VP700- 5PT
		20	40	-1	-0.03 ... -0.34	VP700- 10PT
	NO	35	70	-1	-0.07 ... -0.85	VP700- 30PT

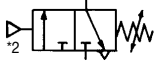
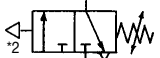

PP700-100PT

Switch with pneumatic output, NC	1/8" NPT male, supply pressure 1.4...8 bar		PP / VP701			
 pressure switch	1.4 ... 8 bar	15	30	2	0.07 ... 0.35	PP701- 5PT
		20	40	4	0.07 ... 1.0	PP701- 15PT
	NC	20	70	4	0.07 ... 2.1	PP701- 30PT
		35	140	8	0.20 ... 4.2	PP701- 60PT
		50	240	8	0.35 ... 7.0	PP701-100PT
 vacuum switch	1.4 ... 8 bar	15	35	-1	-0.03 ... -0.17	VP701- 5PT
		20	40	-1	-0.03 ... -0.34	VP701- 10PT
	NC	35	70	-1	-0.07 ... -0.85	VP701- 30PT



PP / VP FM

Special options, add or change the appropriate letter

flush mounting	barbed fitting made of nylon,	Ø 1/16", Ø 2 mm	.P70-... FMB80
panel mounting	barbed fitting made of nylon,	Ø 1/16", Ø 2 mm	.P70-... PMB80
manifold mounting			.P70-... MM
barbed fitting	for FM and PM,	nylon, Ø 1/16", Ø 2 mm	.P70-... B80
		nylon, Ø 1/8", Ø 4 mm	.P70-... B85
		polysulphone, Ø 1/16", Ø 2 mm	.P70-... P80
		polysulphone, Ø 1/8", Ø 4 mm	.P70-... P85
free of grease and oil	specially cleaned, suitable for oxygen		.P70-... L

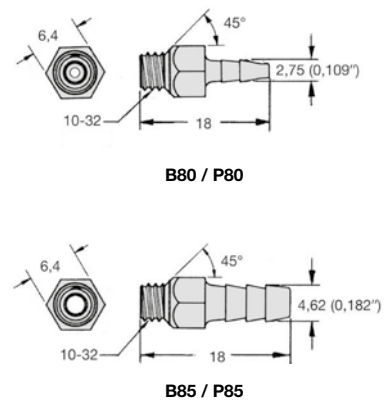
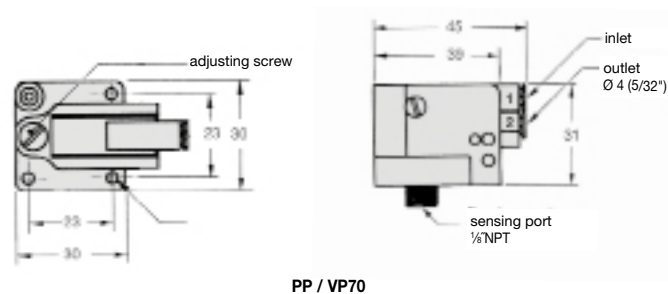

*1 only output signal in the absence of input signal (positive pressure, vacuum)
*2 no output signal in the absence of input signal (positive pressure, vacuum)