

PRESSURE TRANSDUCER

DESCRIPTION	PRESSURE RANGE bar	CONNECTION thread	DEVICE	PAGE
for gases and liquids, also vacuum	0 ... 50 mbar / 1000 bar	G $\frac{1}{8}$ a - G $\frac{1}{2}$ a	D2	13.02
for high temperature, accurate to 0.1%	0 ... 50 mbar / 1000 bar	G $\frac{1}{4}$ m and G $\frac{1}{2}$ m	DA	13.04
for differential pressure, also vacuum	0 ... 1 mbar / 10 bar	G $\frac{1}{8}$	D5	13.05
elekt. signal with pressure indicator	-1 ... 1 mbar / 10 bar	G $\frac{1}{8}$ a	DSB/DSC	13.06



13

Description

Media

Supply voltage

Electrical connector

Output signal

Repeatability

Temperature sensitivity

Ambient temperature

Media temperature

Shock resistance

Material

The operating pressure is converted into a proportional, electrical signal by a ceramics stainless steel pressure transducer. After amplification the signal is monitored as an analogue voltage or current signal. compressed air, natural gases or liquids

12-33 V DC residual ripple 5%, with reverse voltage protection, max. current consumption 4 mA

plug M12x1, 4-pin, with coupling socket **Protection class** IP67 according to DIN EN60529

4-20 mA: max. power consumption 260 mW 0-10 V: max. power consumption 50 mW

< 0,3% v.E **Long-term stability** < 0,3% v.E

< 0,2% v.E **Vibration resistance** 20 g at 15-2000 Hz

from -30 °C to 85 °C

from -40 °C to 125 °C

100 g (11 ms)

Body: Stainless steel 316L, mat. no. 1.4404 O-Ring: FKM, optionally EPDM

Coupling socket: polyacrylamide 50% GF UL 94 V-0 Measuring cell: Stainless steel (bar areas)

ceramics AL₂O₃ (mbar/absolute pressure areas)

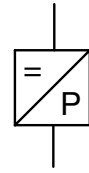

**accurate to 0.3%
compressed air or liquids**

Dimensions			Over-pressure	Under-pressure	Measurement range	Oder number
B	Ø	SW	max. bar	max. bar	bar	(4-20 mA)
mm	mm	mm				

Miniature

G $\frac{1}{4}$ male stainless steel, for compressed air, natural gases or liquids, with angular coupling socket

D2

55	24	24	-1	3,0	-1 ...	0 bar	D2A-V00
				3,0	-1 ...	1 bar	D2A-V01
				4,8	-1 ...	1,5 bar	D2A-V02
				7,5	-1 ...	2,5 bar	D2A-V03
				18	-1 ...	5 bar	D2A-V05
				30	-1 ...	9 bar	D2A-V09
				48	-1 ...	15 bar	D2A-V15
				75	-1 ...	24 bar	D2A-V24
				3,0	0 ...	1 bar	D2A-01
				4,8	0 ...	1,6 bar	D2A-02
				7,5	0 ...	2,5 bar	D2A-03
				12	0 ...	4 bar	D2A-04
				18	0 ...	6 bar	D2A-06
				30	0 ...	10 bar	D2A-10
				48	0 ...	16 bar	D2A-16
				75	0 ...	25 bar	D2A-25
				120	0 ...	40 bar	D2A-40
				180	0 ...	60 bar	D2A-60
				300	0 ...	100 bar	D2A-D1
				480	0 ...	160 bar	D2A-D2
				750	0 ...	250 bar	D2A-D3
				1200	0 ...	400 bar	D2A-D4
				1500	0 ...	600 bar	D2A-D6
				1500	0 ...	1000 bar	D2A-E1



D2



KM-A4-0

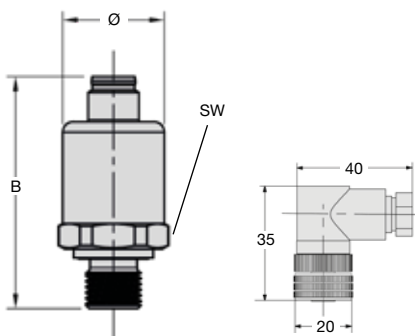

D2V-03

KM12-C4-0

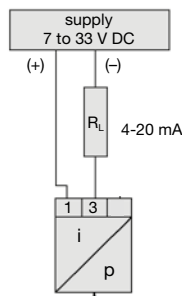

D2A

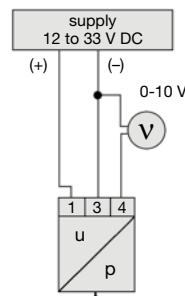

D2V

* Product group

PDF CAD
www.aircom.net



Description	The operating pressure is converted into a proportional, electrical signal by a ceramics stainless steel pressure transducer. After amplification the signal is monitored as an analogue voltage or current signal.		
Media	compressed air, natural gases or liquids		
Supply voltage	12-33 V DC	residual ripple 5%, with reverse voltage protection, max. current consumption 4 mA	
Electrical connector	plug M12x1, 4-pin, with coupling socket	Protection class IP67 according to DIN EN60529	
Output signal	4-20 mA: max. power consumption 260 mW	0-10 V: max. power consumption 50 mW	
Repeatability	< 0,3% v.E	Long-term stability < 0,3% v.E	
Temperature sensitivity	< 0,2% v.E	Vibration resistance 20 g at 15-2000 Hz	
Ambient temperature	from -30 °C to 85 °C		
Media temperature	from -40 °C to 125 °C		
Shock resistance	100 g (11 ms)		
Material	Body: Stainless steel 316L, mat. no. 1.4404	O-Ring: FKM, optionally EPDM	
	Coupling socket: polyacrylamide 50% GF UL 94 V-0	Measuring cell: Stainless steel (bar areas) ceramics AL ₂ O ₃ (mbar/absolute pressure areas)	

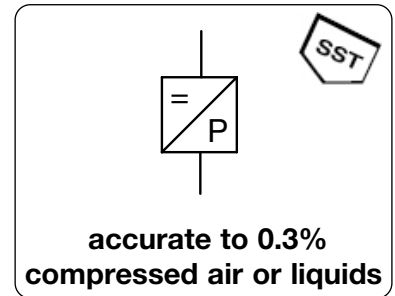

Dimensions			Over-pressure	Under-pressure	Measurement range	Oder number
B	Ø	SW	max. bar	max. bar	bar	(4-20 mA)
mm	mm	mm				

Miniature	G $\frac{1}{4}$ male stainless steel, for compressed air, natural gases or liquids, with angular coupling socket					D2
55 24 24	-0,3	2,0	-50 ...	50 mbar	D2A-B5V	
			-100 ...	100 mbar	D2A-C1V	
			-200 ...	200 mbar	D2A-C2V	
			-300 ...	300 mbar	D2A-C3V	
			-100 ...	0 mbar	D2A-VC1	
			0 ...	50 mbar	D2A-B5	
			0 ...	100 mbar	D2A-C1	
			0 ...	200 mbar	D2A-C2	
			0 ...	300 mbar	D2A-C3	
			0 ...	400 mbar	D2A-C4	
			0 ...	600 mbar	D2A-C6	



Special options, add the appropriate letter or number

0-10 V output signal	D2V - . .
deviant measurement range to be indicated on order	D2 . - . XX
absolute pressure range measurement range from 0 ... 16 bar (Ceramic measuring cell)	D2 . - . A
flush-mounted diaphragm fully welded	D2 . - . F
G $\frac{1}{4}$ male connection thread	D2 . - . 01
G $\frac{1}{2}$ male connection thread	D2 . - . 04
NPT connection thread	D2 . - . N
EPDM elastomers	D2 . - . E
for oxygen specially cleaned from measurement range 1 bar	D2 . - . 15

Accessories, enclosed

coupling socket 4-pin	M12x1, straight	KM12-A4-0	angular	KM12-C4-0
socket with cable	2 m, straight	KM12-A4-2	angular	KM12-C4-2
	5 m, straight	KM12-A4-5	angular	KM12-C4-5

* Product group



PRESSURE TRANSDUCER, 0.1% ACCURATE, FOR HIGH TEMPERATURES, ATEX

DA

Description	Pressure transducer in compact and robust stainless steel housing with piezo-resistive measuring element. Factory-made calibration of zero point and range is possible.
Media	compressed air, non-corrosive gases or liquids
Overpressure	max. 3x full scale, min. 3 bar, for DAA-D6 and DAA-E1 max. 1500 bar
Supply voltage	9...33 V DC at current signal, 15...30 V DC at voltage signal, residual ripple 5%, reverse voltage protection, short-circuit-proof
ATEX version	only current signal 10...30 V DC, max. 1 W, as per EN 50.014 / EN 50.020: 1974 A1...A5, ATEX 2640-1
Electrical connector	plug according to DIN 43650, with coupling socket
Output signal	4...20 mA: max. power consumption 260 mW, 0...10 V: max. power consumption 50 mW
Linearity/Hysteresis	< 0.1% FS
Temperature sensitivity	Repeatability < 0.1% FS Long-term stability < 0.1% FS, < 0.5% FS at version up to 500 mbar
Response time	< 0.02% FS per °C / K, < 0.06% FS at version up to 2 bar per °C / K, at range of 0 °C to 70 °C / 32 °F to 158 °F
Vibration resistance	1 ms for 10...90% of pressure range
Mounting position	10 g at 5...500 Hz
Material	any Shock resistance 50 g Protection class IP 65 Temperature range 0 °C to 70 °C / 32 °F to 158 °F
	Body/Diaphragm: stainless steel 316L, material no. 1.4435 O-rings: FKM, optionally EPDM

-1...1000 bar, accurate to 0.1 %
compressed air or gases

Dimensions			Accuracy	Measurement range	Order number	Measurement range	Order number
B	Ø	A/F	%	mbar/bar	4-20 mA	mbar/bar	4-20 mA
mm	mm	mm					

Pressure transducer				G½ male, SST, overpressure with angular coupling socket, 4-20 mA	DA		
73	24	27	0.1	0... 50 mbar	DAA-B5H		
				0... 100 mbar	DAA-C1H		
				0... 160 mbar	DAA-C2H	0... 10 bar	DAA-10H
				0... 250 mbar	DAA-C3H	0... 16 bar	DAA-16H
				0... 400 mbar	DAA-C4H	0... 25 bar	DAA-25H
				0... 600 mbar	DAA-C6H	0... 40 bar	DAA-40H
				0... 1.0 bar	DAA-01H	0... 60 bar	DAA-60H
				0... 1.6 bar	DAA-02H	0... 100 bar	DAA-D1H
				0... 2.5 bar	DAA-03H	0... 160 bar	DAA-D2H
				0... 4.0 bar	DAA-04H	0... 250 bar	DAA-D3H
				0... 6.0 bar	DAA-06H	0... 400 bar	DAA-D4H
						0... 600 bar	DAA-D6H
						0... 1000 bar	DAA-E1



DAA-C1H



DA-..T

Special options, add the appropriate letter or number

0-10 V output signal	not for Ex ATEX version	DAV-..	
deviant measurement range	to be indicated on order	DA-..XX	
absolute pressure range	from 50 mbar on	DA-..A	
vacuum	0...-1 bar	DA-..V	
Ex-Atex version	Ex II 1G Ex ia IIC T6	4...20 mA only	DAA-..EX
0.25 % linearity	for 100 mbar up to 600 bar		DA-..G
	for 1000 bar		DA-..E1G
-25 to +100 °C/-13 to 212 °F	media temperature compensated up to 85 °C / 185 °F / T4		DA-..S
-25 to +150 °C/-13 to 302 °F	media temperature compensated up to 85 °C / 185 °F / T3		DA-..T
flush-mounted diaphragm	connection thread G½, also for vacuum, up to 600 bar		DA-..F
G½ male	connection thread		DA-..04
EPDM elastomer			DA-..E
silicone-free oil-refill			DA-..X32

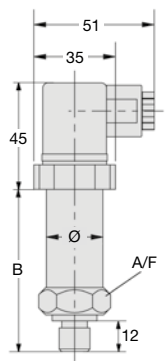

version	B (mm)
standard	73
standard 150 °C	100
Ex	122
Ex, T3	149

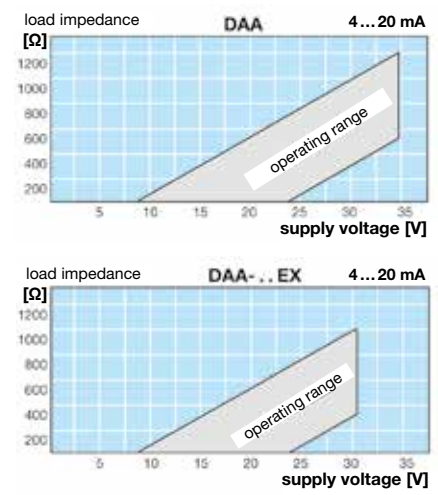
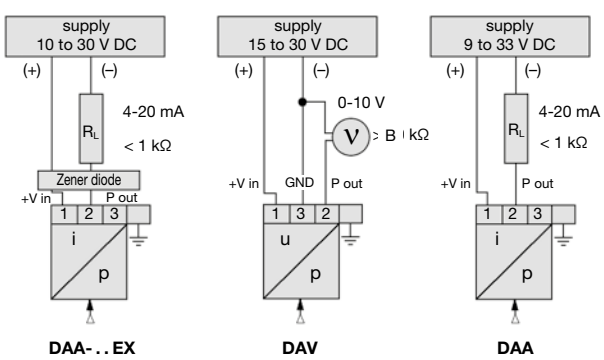

* Product group Order example: DAA-B5H

Description	The differential pressure between port H and L is converted into a proportional, electrical signal by a silicon pressure transducer, amplified and then monitored as an analogue voltage or current signal.		
Media	compressed air or non-corrosive gases		
Supply voltage	12...32 V DC, residual ripple 5%	with voltage protection	
Electrical connector	plug M12x1, 4-pin, optionally 4-wire connection cable		
Output signal	4...20 mA: max. power consumption 260 mW	1...6 V: max. power consumption 60 mW	
Linearity/Hysteresis	< 0.1 % FS typ.	< 0.25% FS	
Repeatability	< 0.1 % FS typ.	< 0.5 % FS	
Long-term stability	< 0.2 % FS typ.	< 0.5 % FS	
Temperature sensitivity	< 0.02% FS typ. per °C at 0 to 50 °C / 32 to 122 °F	< 0.16% FS typ. per °C at 0 to 50 °C	
Response time	1 ms for 10...90% of pressure range	Shock resistance 50 g	
Vibration resistance	10 g at 5...500 Hz	Protection class IP 67 with plug mounted	
Mounting position	upright	Temperature range -25 °C to 85 °C / -13 °F to 185 °F	
Material	Body: aluminium		

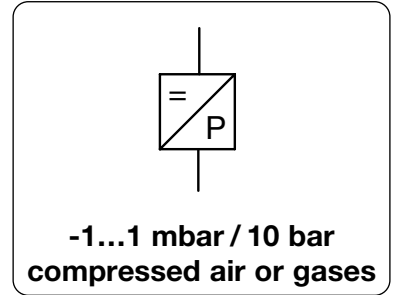

Dimensions		Differential pressure	Overpressure	Measurement range	Order number
B	Ø	max. bar	both ports max. bar	mbar/bar	
mm	mm				E*

Differential pressure transducer 4-20 mA				G½, 2-wire, with angular coupling socket	D5	
86	40	0.25	0.5	0... 1 mbar	D5A-A1*1	
					-1... 1 mbar	D5A-A1V
					0... 2 mbar	D5A-A2*1
86	40	0.35	0.75	-2... 2 mbar	D5A-A2V	
				0... 5 mbar	D5A-A5*1	
				-5... 5 mbar	D5A-A5V	
86	40	0.35	3.5	0... 10 mbar	D5A-B1*1	
				-10... 10 mbar	D5A-B1V	
				0... 25 mbar	D5A-B2	
86	40	1.4	12	-25... 25 mbar	D5A-B2V*1	
				0... 70 mbar	D5A-B7	
				-70... 70 mbar	D5A-B7V	
86	40	2	12	0... 350 mbar	D5A-C3	
				-350... 350 mbar	D5A-C3V*1	
				0... 1 bar	D5A-O1	
86	40	4	12	-1... 1 bar	D5A-V1	
				0... 2 bar	D5A-O2*1	
				0... 5 bar	D5A-O5*1	
		10	20	0... 10 bar	D5A-10*1	

Special options, add the appropriate letter or number

1-6 V	output signal, from measurement range 2 mbar > 10 mbar*1	D5V-...
1 m connection cable	fixed at the device	D5...L*1

Accessories, enclosed

coupling socket 4-pin	M12x1, straight	KM12-A4-0	angular	KM12-C4-0
socket with cable	2 m, straight	KM12-A4-2	angular	KM12-C4-2
	5 m, straight	KM12-A4-5	angular	KM12-C4-5



D5 D5-L1

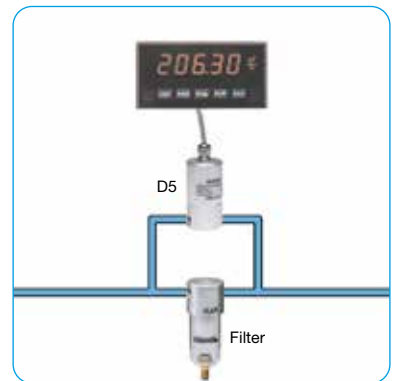

example: filter control

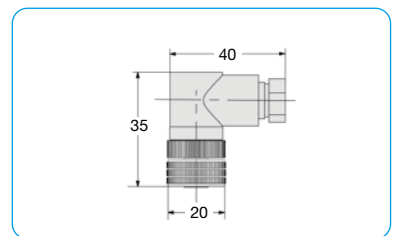

KM12-C4-0

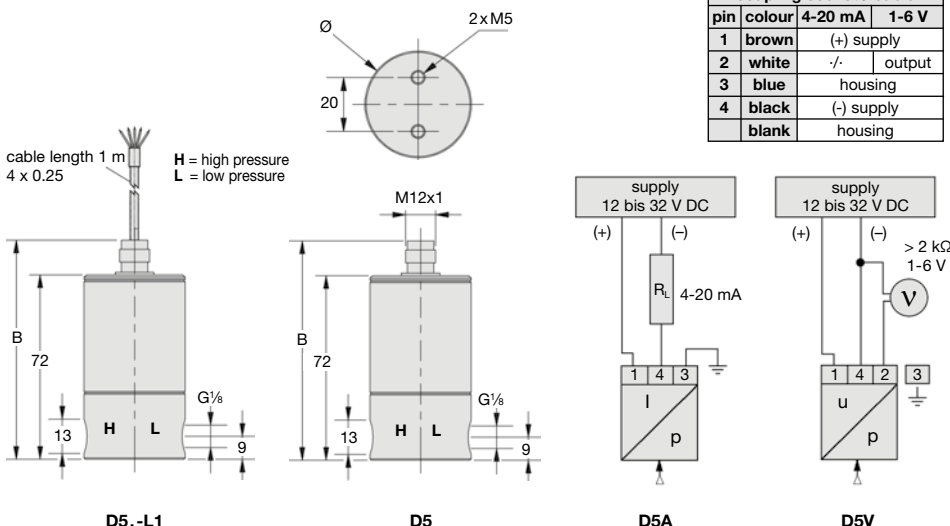

coupling socket / cable		
pin	colour	4-20 mA 1-6 V
1	brown	(+) supply
2	white	-/- output
3	blue	housing
4	black	(-) supply
blank		housing

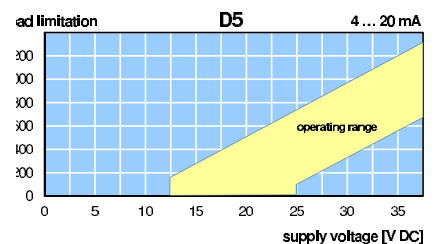

*1 Minimum order quantity 5 pieces

* Product group

Test chart: see chapter "Technical information"

PDF CAD
www.aircom.net



Order example:
D5A-A1

PROGRAMMABLE VACUUM AND PRESSURE SWITCH TRANSDUCER WITH DISPLAY DSB / DSC

Description	Pressure to the unit is continuously monitored by a piezo-resistive sensor and converted into a proportional voltage signal. The signal is then amplified and delivered as a PNP signal. dry, lubricated or unlubricated compressed air or non-corrosive gases	
Media	12 ... 30 V DC, reverse voltage protection, current consumption max. 30 mA, output current max. 250 mA	
Supply voltage	Mode: hysteresis or window, switching point and hysteresis, NO or NC, closing or opening time, bar, psi, MPa, kg/cm ² etc. Display: current pressure, highest pressure, measurement errors	
Adjustment	DSB	2x PNP freely programmable as NO or NC, max. contact load 250 mA, short-circuit-proof
Switching output	DSB	1x PNP as at DSB and 1x analogue output signal 1...5 V, output impedance < 500 Ω
Switching output	DSC	adjustable from 0% to 100% of set switching point
Hysteresis		Linearity < 1% FS
Repeatability		Switching frequency 200 Hz
LED display		Mounting position any
Error display		Shock resistance 10 g
Certifications		Protection class IP 65
Temperature range		Connection thread: nickel-plated brass
Material	Body: ABS-PC plastic, shockproof	

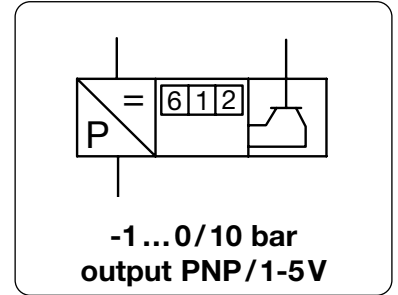

Dimensions	Digital display	Over-pressure	Output signal type	Measurement range	Order number
B	Ø	max. bar	PNP/analog	max. mA	
mm	mm			bar	

Sensor pressure switch					connection thread G½ male, without coupling socket, M8x1, 4-pin	DS	
57	16	with	2	2x PNP	250	0 ... -1 -1 ... +1 0 ... 10 -1 ... 10 0 ... 12	DSB-V1 DSB-V2 DSB-10 DSB-V10 DSB-12
44	16	without	2	1x PNP/1x analog	250	0 ... -1 -1 ... +1 -1 ... 10	DSC-V1 DSC-V2 DSC-V10



Accessories, enclosed

coupling socket	M8x1, 4-pin with 5 m cable	straight	KM8-A4-5
		angular	KM8-C4-5

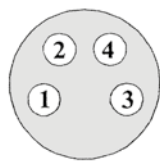
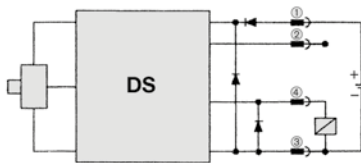

PIN configuration DIN EN 50044		
pin	colour	configuration
1	brown	24 V DC (+)
2	white	outlet 2 / analog
3	blue	24 V DC (-)
4	black	outlet 1 / digital

PIN configuration according to DIN EN 50044

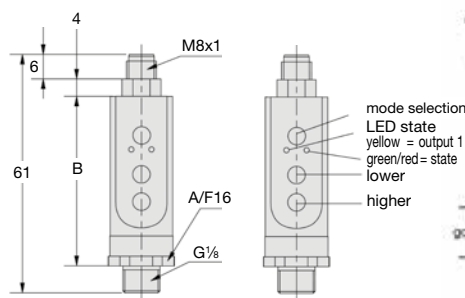
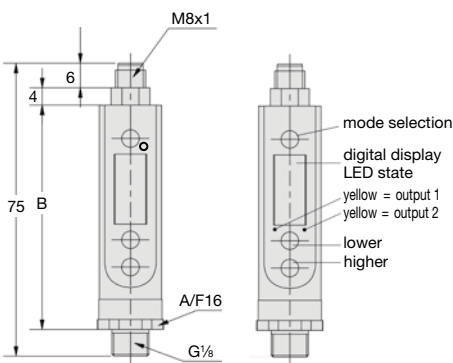
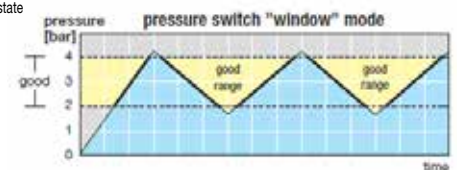
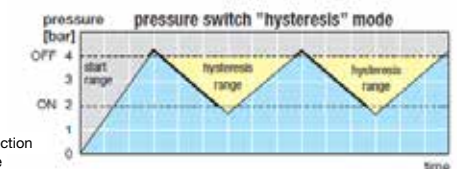
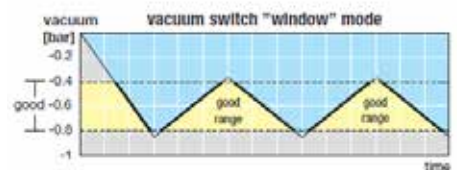
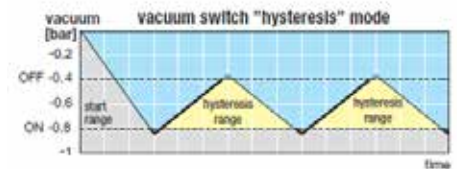

* Product group

PDF CAD
www.aircom.net



Order example:
DSB-V1