

Description	2-way proportional flow valve controls the volume flow of maximum 1185 l/min for air in proportion to the input signal of 0 to 10 V or 0/4 to 20 mA. The proportional valve and the electronic control unit are ordered separately.
Product selection	To achieve the best linear flow characteristics, it is advisable not to reduce the flow too much and to have enough pressure drop at the valve for good control. Reference value: at the valve > 30% of the total pressure drop.
Installation hint	The nominal width of the orifice following the proportional valve should not be smaller than the nominal width of the valve. A constriction of the cross-section after the valve should be categorically avoided!

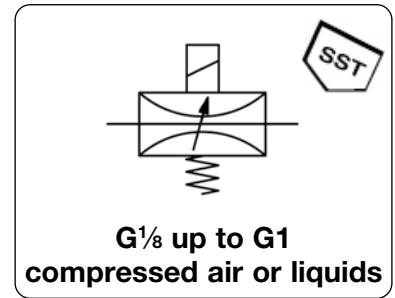

General technical features

Design	2-way proportional flow valve, normally closed during absence of current, with additional control module in cable plug or in housing for DIN rail mounting.		
Mounting position	any, preferably upright		
Protection class	IP 65 with coupling socket, IP 40 for DIN rail version		
Temperature range	-10 °C to 90 °C / 14 °F to 194 °F for media -10 °C to 55 °C / 14 °F to 131 °F for electronics		
Material	Body: brass Elastomer:	Inner valve: FKM	brass and stainless steel Control housing: plastic

Pneumatic features

Media	compressed air, non-corrosive gases or liquids, max. viscosity 21 mm ² /s, PV40 for liquids only
Operating pressure	see chart, max. 16 bar
Flow rate	0...2 / 1185 l/min for air, 0...0.03 / 83 l/min for liquids in detail see chart, at max. supply pressure and Δp = 1 bar

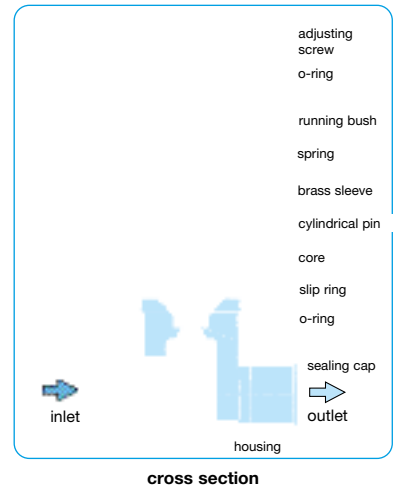

Electrical features

Supply voltage 24 V DC ± 10%, residual ripple max. 5%, with reverse voltage protection

Power consumption	electronic	PV21	PV21	PV22	PV34	PV40-04	PV40-06	PV40-08
	1 W	2 W to DN 0.6	5 W from DN 0.8 on	9 W	16 W	8 W	10 W	15 W

Command signal 0-5 V, 0-10 V, 0-20 mA or 4-20 mA selectable

Impedance > 20 kΩ at voltage signal
< 200 Ω at current signal

Electrical connector PV21: square connector according to DIN 43650 form B
PV22...PV40: square connector according to DIN 43650 form A

Accuracy

Linearity	< 10 % FS		
Hysteresis	< 5 % FS		
Response sensitivity	< 0.1% FS at DN < 0,8 mm,	< 0.25% FS at DN ≥ 0,8 mm,	< 1% FS at PV40
Repeatability	< 0.25% FS at PV22 < 0.5% FS		
Regulating time	PV21: < 15 ms,	PV22: < 20 ms,	PV34: < 50 ms, PV40: < 200 ms each for 90% of the range

Adjustment

Zero point	The zero point can be decreased or increased.
Range	The range can be decreased or increased.
Ramp	The ramping potentiometer adjusts the time delay with a range of 0 to 10 s in order to dampen sudden changes of the setpoint. Increasing and decreasing ramps have the same delay.
Zero point switch	Using a DIP switch, the zero point switch can be activated or deactivated. It is not necessary to have another switch-off valve.

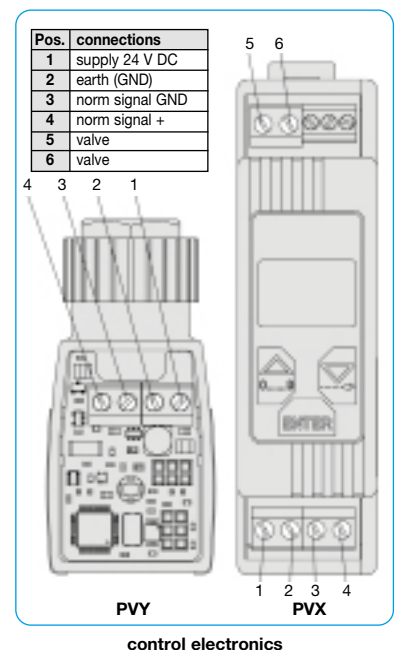

* Product group



Technical features	
• Media	compressed air, non-corrosive gases or liquids, except for PV40
• Signal range	0-5 V, 0-10 V, 0-20 mA, 4-20 mA
• Pressure range	vacuum ... 2 / 16 bar
• Orifice	DN 0.1 ... DN 20
• Flow rate	max. 1185 l/min for air, max. 90 l/min for water
• Adjustment	zero point, range and ramp
• Zero switch-off	ensures reliable closure of the valve
• Linearity	< 10% FS
• Hysteresis	< 5% FS
• Response sensitivity	< 0.1% FS at DN < 0.8 mm < 0.25% FS at DN ≥ 0.8 mm < 1% FS at PV40
• Repeatability	< 0.25% FS, < 0.5% FS at PV22
• Regulating time	depending on type: < 15 ms, < 20 ms, < 50 ms or < 200 ms
• Protection class	IP65 with plug
• Impedance	> 20 kΩ at V, < 200 Ω at mA

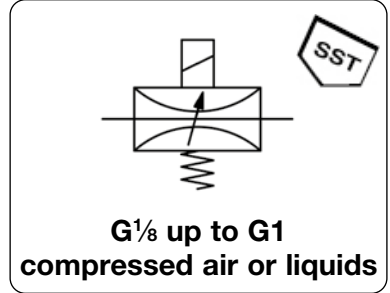

Dimensions			Nominal K _v -size	Flow rate		Operating pressure	Differ. press.	Connection thread	Order number
A	B	C	DN (m ² /h)	water l/min*1	air l/min*2	max. bar	max. bar	G	

Proportional flow valve										without electronics, brass, FKM, for compressed air, vacuum or liquids*2	PV	
25	50	7	0.1	0.0025	0...	0.004	0...	0.27	10	10	G1/8	PV21-01
25	50	7	0.2	0.001	0...	0.017	0...	1.0	10	10	G1/8	PV21-02
25	50	7	0.3	0.002	0...	0.033	0...	2.2	10	10	G1/8	PV21-03
25	50	7	0.4	0.004	0...	0.067	0...	4.0	8	8	G1/8	PV21-04
25	50	7	0.6	0.010	0...	0.167	0...	11	6	6	G1/8	PV21-06
25	50	7	0.8	0.018	0...	0.3	0...	19	12	6	G1/8	PV21-08
25	50	7	0.8	0.018	0...	0.3	0...	19	12	12	G1/8	PV21-08B
25	50	7	1.0	0.027	0...	0.3	0...	19	10	5	G1/8	PV21-10
25	50	7	1.0	0.027	0...	0.3	0...	19	10	10	G1/8	PV21-10B
25	50	7	1.2	0.038	0...	0.633	0...	41	8	4	G1/8	PV21-12
25	50	7	1.2	0.038	0...	0.633	0...	41	8	8	G1/8	PV21-12B
25	50	7	1.6	0.055	0...	0.917	0...	59	6	3	G1/8	PV21-16
25	50	7	1.6	0.055	0...	0.917	0...	59	6	6	G1/8	PV21-16B
25	50	7	2.0	0.090	0...	1.5	0...	97	3	1.5	G1/8	PV21-20
25	50	7	2.0	0.090	0...	1.5	0...	97	3	3	G1/8	PV21-20B
32	66	8.5	0.8	0.018	0...	0.3	0...	19	16	8	G1/8	PV22-08
32	66	8.5	0.8	0.018	0...	0.3	0...	19	16	16	G1/8	PV22-08B
32	66	8.5	1.0	0.027	0...	1.0	0...	65	14	7	G1/8	PV22-10
32	66	8.5	1.0	0.027	0...	1.0	0...	65	14	14	G1/8	PV22-10B
32	66	8.5	1.2	0.040	0...	0.67	0...	43	12	6	G1/8	PV22-12
32	66	8.5	1.2	0.040	0...	0.67	0...	43	12	12	G1/8	PV22-12B
32	66	8.5	1.5	0.060	0...	1.0	0...	65	10	5	G1/8	PV22-15
32	66	8.5	1.5	0.060	0...	1.0	0...	65	10	10	G1/8	PV22-15B
46	72	8.5	2.0	0.10	0...	1.66	0...	108	8	4	G1/4	PV22-20
46	72	8.5	2.0	0.10	0...	1.66	0...	108	8	8	G1/4	PV22-20B
46	72	8.5	2.5	0.15	0...	2.5	0...	162	5	2.5	G1/4	PV22-25
46	72	8.5	2.5	0.15	0...	2.5	0...	162	5	5	G1/4	PV22-25B
46	72	8.5	3.0	0.22	0...	3.67	0...	237	3.5	1.8	G1/4	PV22-30
46	72	8.5	3.0	0.22	0...	3.67	0...	237	3.5	3.5	G1/4	PV22-30B
46	72	8.5	4.0	0.32	0...	5.33	0...	345	2	1	G1/4	PV22-40
46	72	8.5	4.0	0.32	0...	5.33	0...	345	2	2	G1/4	PV22-40B



PV21



PV22

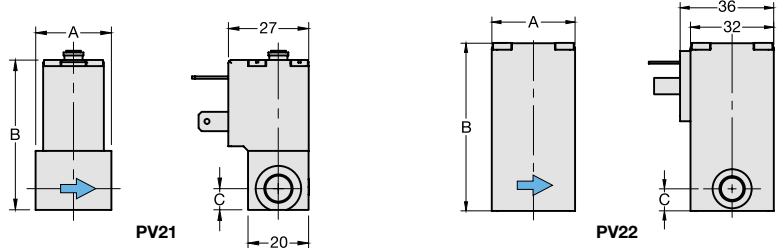

*1 at max. operating pressure and Δp = 1 bar *2 at pressure drop from 6 bar down to 5 bar

Media		Technical features	
Media	compressed air, non-corrosive gases or liquids, except for PV40	Linearity	< 10% FS
Signal range	0-5 V, 0-10 V, 0-20 mA, 4-20 mA	Hysteresis	< 5% FS
Pressure range	vacuum...2 / 16 bar	Response sensitivity	< 0.1% FS at DN < 0.8 mm < 0.25% FS at DN ≥ 0.8 mm < 1% FS at PV40 < 0.25% FS, < 0.5% FS at PV22
Orifice	DN 0.1 ... DN 20	Repeatability	< 0.25% FS, < 0.5% FS at PV22
Flow rate	max. 1185 l/min for air, max. 90 l/min for water	Regulating time	depending on type: < 15 ms, < 20 ms, < 50 ms or < 200 ms
Adjustment	zero point, range and ramp	Protection class	IP65 with plug
Zero switch-off	ensures reliable closure of the valve	Impedance	> 20 kΩ at V, < 200 Ω at mA

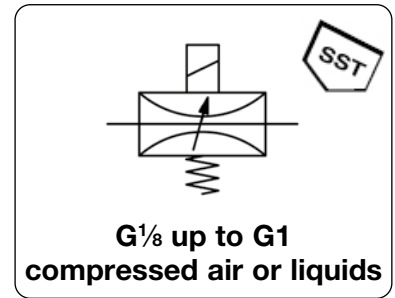

Dimensions			Nominal K _v -	Flow rate		Operating	Differ.-	Connection	Order	
A	B	C	size	water	air	pressure	press.	thread	number	E*
mm	mm	mm	DN (m ³ /h)	l/min*1	l/min*2	max. bar	max. bar	G		

Proportional flow valve										without electronics, brass, FKM, for compressed air, vacuum or liquids*2	PV
55	105	11	4.0	0.45	0... 7.5	0... 485	8	4	G ³ / ₈		PV34-40
55	105	11	4.0	0.45	0... 7.5	0... 485	8	8	G ³ / ₈		PV34-40B
55	105	11	6.0	0.80	0... 13.3	0... 860	4	2	G ¹ / ₂		PV34-60
55	105	11	6.0	0.80	0... 13.3	0... 860	4	4	G ¹ / ₂		PV34-60B
55	105	11	8.0	1.10	0... 18.3	0... 1185	2	1	G ¹ / ₂		PV34-80
55	105	11	8.0	1.10	0... 18.3	0... 1185	2	2	G ¹ / ₂		PV34-80B
50	89	12	10	1.4	0... 25.0*3	-	10		G ¹ / ₂		PV40-04
58	110	14	13	2.5	0... 45.0*3	-	10		G ³ / ₄		PV40-06
80	155	16	20	5.0	0... 90.0*3	-	10		G1		PV40-08



Special options, add the appropriate letter

stainless steel body SST 316, W.-No. 1.4401 for PV21 to PV34 PV...S

Accessories, enclosed		
plug electronics	24 V DC, 0-5 V, 0-10 V, 0/4 mA-20 mA	for PV22 to PV40 PVY-06
clip-on electronics	24 V DC, 0-5 V, 0-10 V, 0/4 mA-20 mA	for PV21 PVX-01
		for PV22 to PV40 PVX-02
coupling socket	according to DIN 43650 form B	for PV21 2285-0
	according to DIN 43650 form A	for PV22 to PV40 2286-0

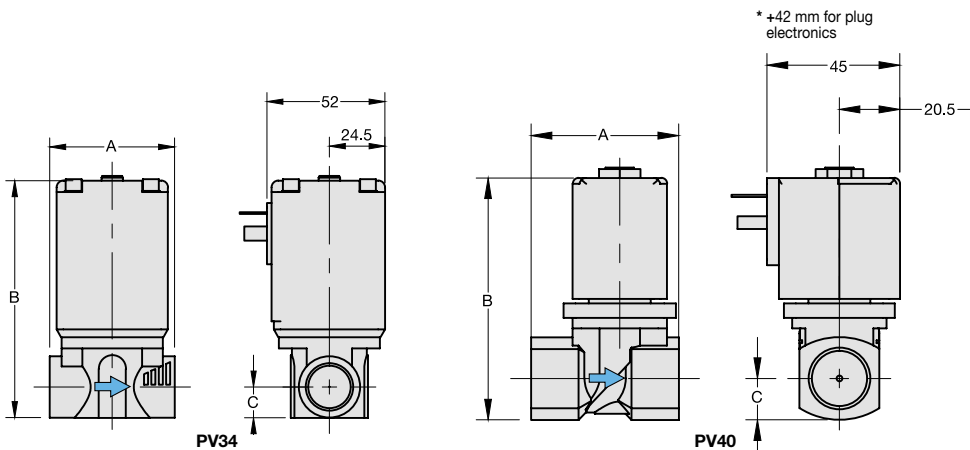

*1 at max. operating pressure and Δp = 1 bar *2 at pressure drop from 6 bar down to 5 bar
*3 PV40 is not suitable for compressed air and vacuum, since pilot-controlled

Technical informations: see previous page

PDF CAD
www.aircom.net

* Product group



Order example:
PV34-40